

# CIRCUIT CONNECTOR RIGHT ANGLE

- Metal Shell Connector
- Surface Mount .025 x .040 (Style 38)
- 1 Piece Contact
- Flat Tail Termination
- Operating Temperature -50° C to 200° C
- 9 to 65 Contacts

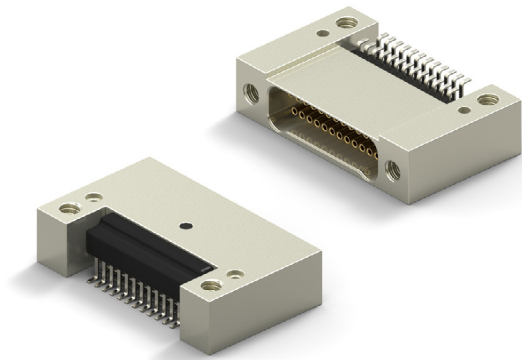











NANO D – PID 137

## HOW TO ORDER

\* Indicates preferred standard \*\* Consult factory for other plating options

**CN M 38 L 25 - 2 P Ø7 1 - SØ1**

CN	Series	Style	Insulator	Contacts	Insulator Type	Contact Gender	Hardware	Lead Finish	Finish**	Temp Range	Mounting Option
CN=Nano	M= Metal Shell	STYLE=38	L=LCP	Ø9	2= Dual Row	S=Female/Socket (Receptacle Side)	Ø7=Threaded Hole	1= Tin plated (6Ø/4Ø)	Blank= Cadmium	*Blank = 125C	*Blank=Threaded Mounting Holes
				15				2= Gold plated (RoHS)		HT = 200°C Supplied with Gold Plated Leads	
				21					*SØ1= Nickel		1= Alignment Posts with Threaded Mounting Holes
				25							
				31					SØ3 = Black Anodize		2= Clearance Mounting Holes
				37							
				51					SØ9= Stainless		3=Alignment Posts with Clearance Mounting Holes
				65							

# DIMENSIONS

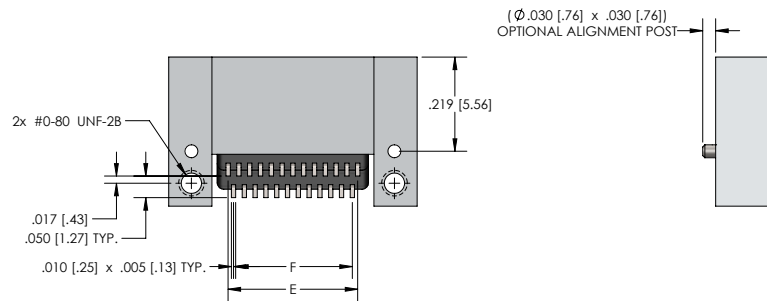
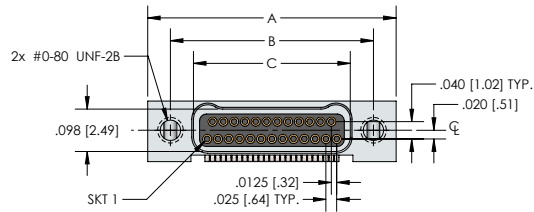
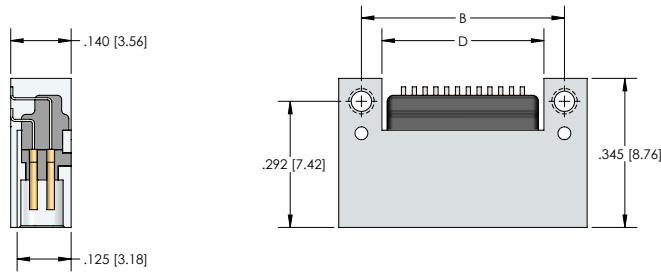

CNM38 SERIES (DUAL ROW)								
Size	A	B	Plug	C	Receptacle	D	E	F
9	.375 [9.52]	.270 [6.86]	.160 [4.06]	.163 [4.14]	.175 [4.44]	.100 [2.54]	.075 [1.90]	
15	.450 [11.43]	.345 [8.76]	.235 [5.97]	.238 [6.04]	.250 [6.35]	.175 [4.44]	.150 [3.81]	
21	.525 [13.33]	.420 [10.67]	.310 [7.87]	.313 [7.95]	.325 [8.25]	.250 [6.35]	.225 [5.71]	
25	.575 [14.60]	.470 [11.94]	.360 [9.14]	.363 [9.22]	.375 [9.52]	.300 [7.62]	.275 [6.98]	
31	.650 [16.51]	.545 [13.84]	.435 [11.05]	.438 [11.12]	.450 [11.43]	.375 [9.52]	.350 [8.89]	
37	.725 [18.41]	.620 [15.75]	.510 [12.95]	.513 [13.03]	.525 [13.33]	.450 [11.43]	.425 [10.79]	
51	.900 [22.86]	.795 [20.19]	.685 [17.40]	.688 [17.47]	.700 [17.78]	.625 [15.87]	.600 [15.24]	
65	1.075 [27.30]	.970 [24.64]	.860 [21.84]	.863 [21.92]	.875 [22.22]	.800 [20.32]	.775 [19.68]	

# CIRCUIT CONNECTOR RIGHT ANGLE PCB LAYOUT FEMALE

NANO D – PID 137

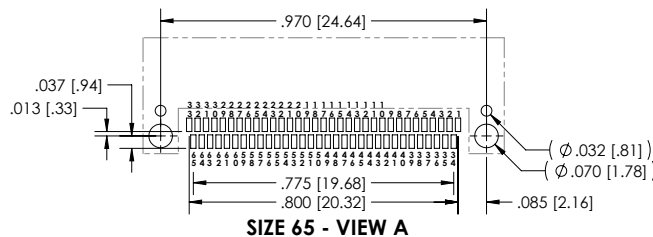
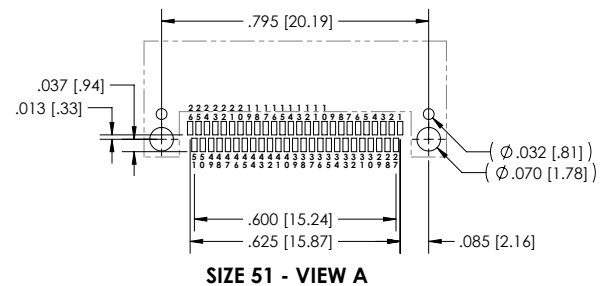
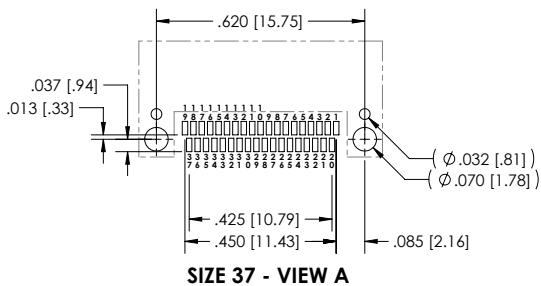
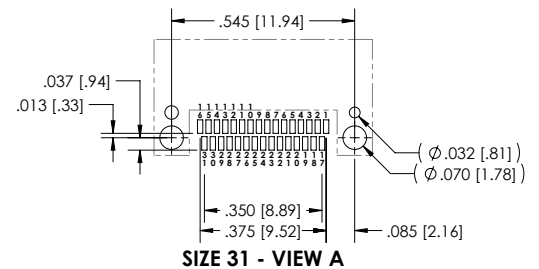
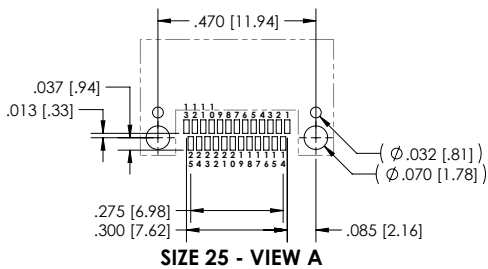
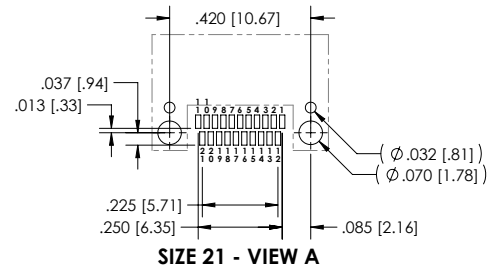
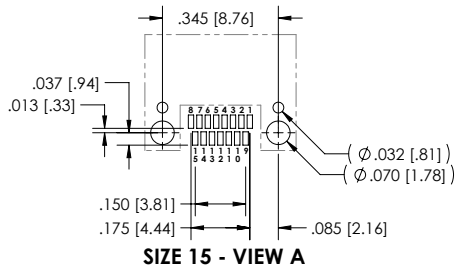
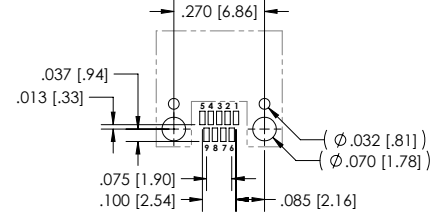
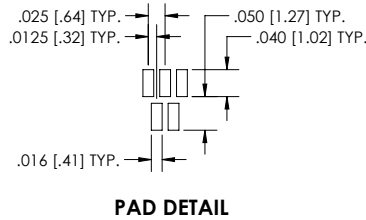
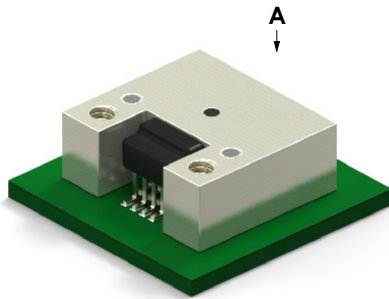

# NANO-D CIRCUIT RIGHT ANGLE CONNECTOR METAL PERFORMANCE DATA, MATERIALS AND FINISHES

## PERFORMANCE DATA

133-E	ELECTRICAL
<b>CONTACT RESISTANCE:</b>	0.033 mΩ max. @ 1.0 A
<b>CURRENT RATING (SIGNAL CONTACTS):</b>	1.0 A max.
<b>DIELECTRIC WITHSTANDING VOLTAGE:</b>	250 VAC at sea level , 100 VAC at 70,000 ft.
<b>INSULATION RESISTANCE:</b>	5,000 MΩ min.

123-M	MECHANICAL
<b>CONTACT ENGAGING FORCE:</b>	5 oz max. (Contact average is 2 oz.)
<b>CONTACT SEPARATING FORCE:</b>	0.4 oz. min.
<b>CONNECTOR MATING FORCE:</b>	7 oz. x number of contacts max.
<b>CONNECTOR UNMATING FORCE:</b>	7 oz. x number of contacts max.
<b>VIBRATION:</b>	No damage or interruption detected (one microsecond sensitivity) EIA-364-28 Condition IV
<b>SHOCK:</b>	No damage or interruption detected (one microsecond sensitivity) EIA-364-28 Condition IV
<b>DURABILITY:</b>	No mechanical or electrical defects after 200 matings.
<b>SALT SPRAY:</b>	No exposure of base metal or loss of performance after 96 hours for both Nickel and Cadmium plating

## MATERIALS AND FINISHES

131-M&F	MATERIALS AND FINISHES
<b>Pin Contacts</b>	Pins: BeCu alloy strip per ASTM-B-194
<b>Socket Contacts</b>	Sockets: BeCu per ASTM-B-194
<b>Contact Plating</b>	Gold plate per ASTM B488, or SAE AMS 2422
<b>Metal Shells</b>	Aluminum alloy per SAE-AMS-QQ-A-200/8, Type 6061-T6, with electroless nickel SAE AMS2404, class 3 or 4 Aluminum alloy per SAE-AMS-QQ-A-200/8, Type 6061-T6, with cadmium plating per SAE-AMS-QQ-P-416, Type II, class 1 Aluminum alloy per SAE-AMS-QQ-A-200/8, Type 6061-T6, with black anodize plating per MIL-A-8625, Type III, class 2 Stainless Steel per ASTM A582
<b>Molded Insulator Into Metal Housing/Lead Organizer</b>	LCP (Liquid Crystal Polymer) GLCP-30F OR PPS PER MIL-M-24519 GST-40F
<b>Alignment Post</b>	Corrosion resistant steel per ASTM A 582/A582 or ASTM A 581/A581M, Passivated per SAE AMS-2700